

HD Network mini PTZ Camera

Quick operation manual V1.1-H

Install

1.Basic Requirement

All Electrical Equipment should be according with the local latest electrical code standards . Pls according with the P.L double check all attachment are included or not . Pls check the application and install way fit with the requirement or not ,If not Pls as the real working environment to use this product .

2.Equipment Install

The equipment support with ceiling mounted and wall mounted two different install way . The Thickness of wall must be can stand the weight are 3times of the equipment

2-1 Wall mounted install

Pls Choose cleanly ,smooth wall . Drilled hole according with the bracket hole . Putting with the bulged tube .

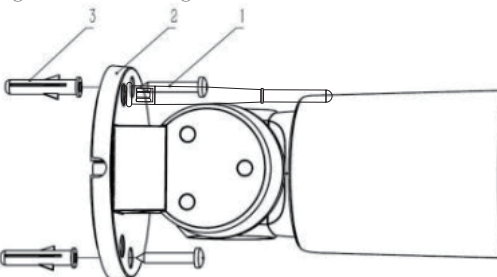

1. Bolts 2 .Bracked . 3.bulged tube

2-2Ceiling Mounted install

Pls Choose cleanly ,smooth wall . Drilled hole according with the bracket hole . Putting with the bulged tube ,Then Fixed the camera under the ceiling

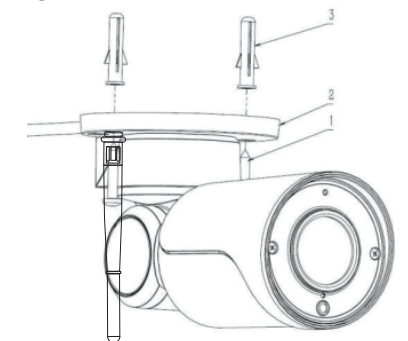

1. Bolts 2 .Bracked . 3.bulged tube

2-3 Wall mounted and ceiling mounted can optional .

The default of the Equipment are wall mounted , The ceiling way need change by urself as picture .

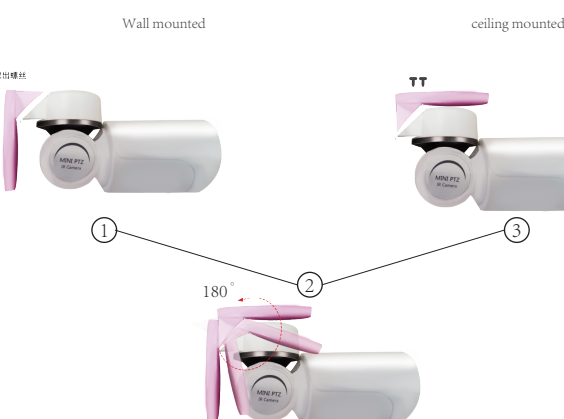

3.Install Micro SD Card (Optional)

Pls open the 2 pcs bolts from the front cover . As picture using tool in packing box to grap the bolts , Two bolts take turns ,Then take out the front cover from camera boby .The Micro SD Card solt will be on the PCB . Put on ur SD Card ,Then install well the front cover .

diagrammatic of open front cover

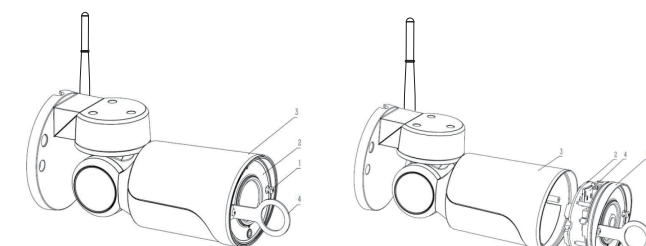

1. Bolts ,2 ,Front cover 3. case ,4.tool

connection

Full camera picture show

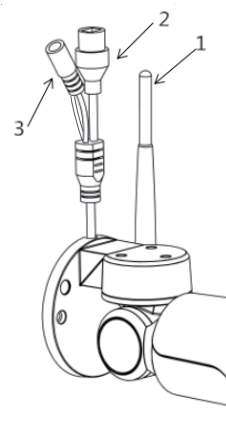

- 1.WIFI : When don' t using cable connect can using Wireless
- 2.Network connector : when Using wired connect with PC and Internet via router
- 3.Power connector : Connect with Power adapter (This product using DC12V,0-2A Power) .
- 4.Photosensitive : Product auto adjust IR according with environment .

1.WIFI 2.Network connector 3.Power connector 4.Photosensitive

Equipment connect

1.Power connector

Pls connect power for the camera .

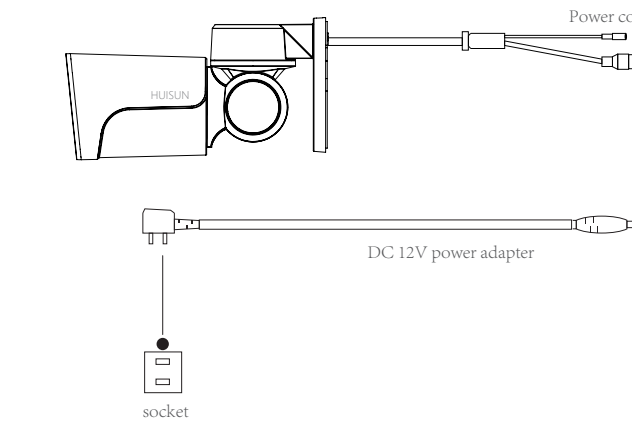

2.Connect with the wired

If u need connect with the wired network ,need network cable router . Notice: the router must work normaly with network , make sure the device ip address , gateway and setting of DNS must be in accord with the router, otherwise the device can not access the network .

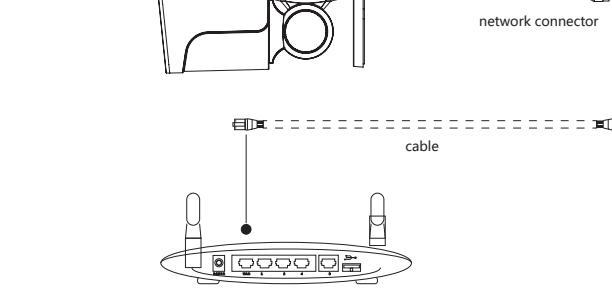

Need ready the cable and router by urself

Manual of IE login

1.User login

Factory default ip address of the camera : 192.168.0.99
Account : admin password : admin

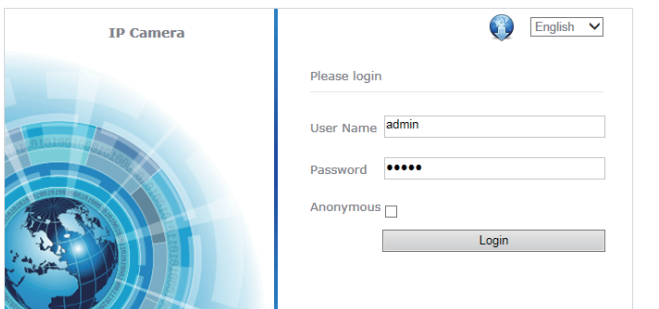

2.Plug Installed

The first time login camera need install the plug-in as the remind (noted , when Installed the plug- Pls close IE Browse .) As picture

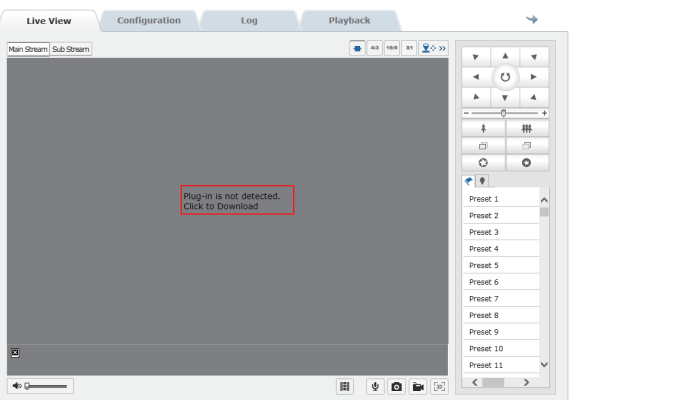

Pls make sure closed “IE” ,When u are installed the plug. According the guide to install ,then click finished.

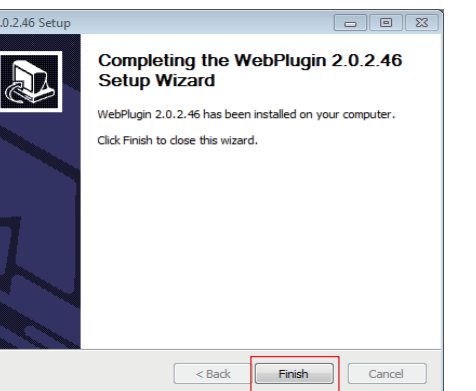

If on Preview page remind “already stop this side send by unsafe way to send message Activex” Then Pls connect to IE - Tool Option - Internet option -” save” to set .

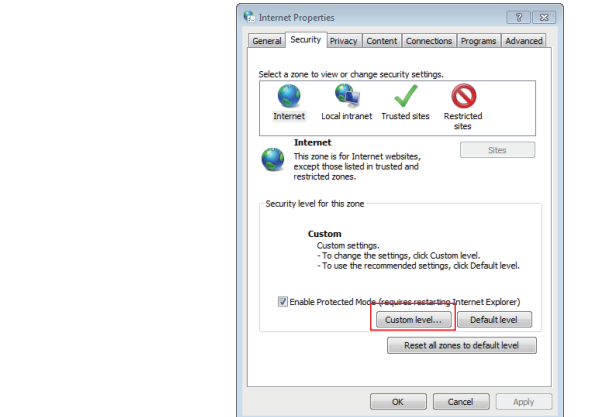

Atten : If install well the plug-in ,login in ,still not video , Pls check as following picture ,then install again with plug-in .

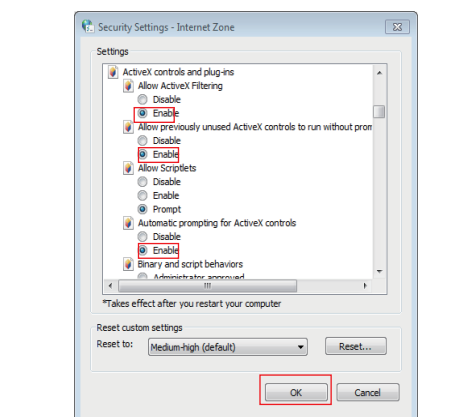

After install well the plug ,login with the camera as correct password and account . Then will connect the control interface .

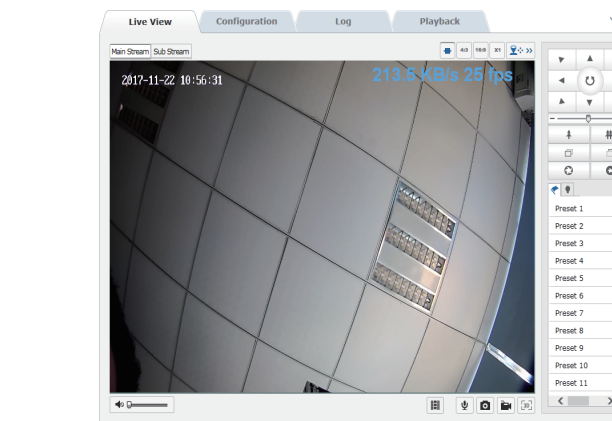

WIFI Connect manual

1.WIFI Connect

1.Go to WIFI connect interface : configuration -network -WIFI ;Open WIFI function ,double click chose the equipment which need to connect wifi ,put with the password, then click :save” .And the status will be “ connecting” .

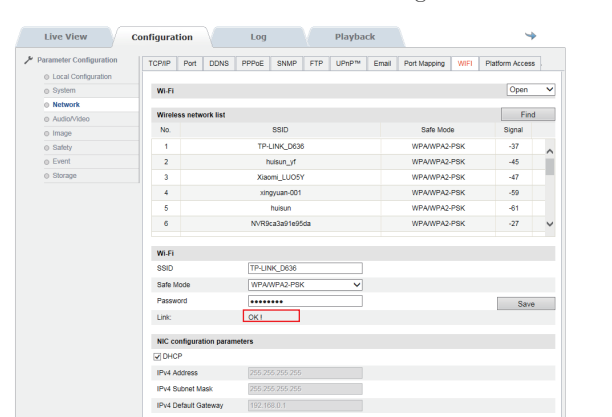

2.he status of wifi will be turn to “OK” after a second ,if not ,Pls refresh .

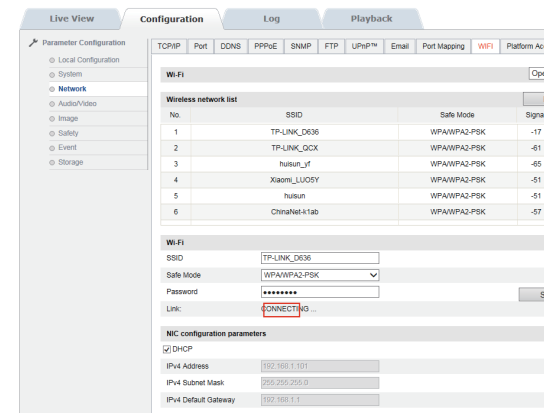

3.After wifi connect well ,don’ t need wired . Can control camera via WIFI . Using “BatchControl” tool can check the camera IP address ,(The IP have”WIFI” Remark) also can use this IP address login in the camera (Atten :Those two IP address(camera default IP ,the Router offer IP) can not on the same network ,If on the same must be change one) .

